

# K3-A

## USER MANUAL

Ver.1.0.6

Last updated:2017/07/24

**Thank you for choosing K3-A flight controller. Hope you will have a good flight with K3-A. We strongly recommend you to read this manual carefully before you install K3-A flight controller. The following instructions will help you to make your K3-A flight controller work perfectly.**

**Note: This manual shall be used together with the K3-A assistant software. If you find differences between this manual and the assistant software, please follow the assistant software.**

**If you have any difficulty during the usage, please contact with JIYI Robotic Co., Ltd. at [support@jiyuav.com](mailto:support@jiyuav.com)**

# Content

<b>1. Technical Terms and Abbreviations .....</b>	<b>5</b>
<b>2. Packing List.....</b>	<b>5</b>
<b>3. Setup Wizard.....</b>	<b>6</b>
<b>3.1 Aircraft Types .....</b>	<b>6</b>
<b>3.2 Wiring Diagram .....</b>	<b>6</b>
<b>3.3 FCU Setup .....</b>	<b>8</b>
<b>3.4 GPS Setup .....</b>	<b>8</b>
<b>4. Configuring by Assistant Software.....</b>	<b>10</b>
<b>4.1 Installing driver and Assistant Software .....</b>	<b>10</b>
<b>4.2 Connect to the FCU .....</b>	<b>11</b>
<b>4.3 The configuration FCU .....</b>	<b>12</b>
<b>5. Fligth .....</b>	<b>13</b>
<b>5.1 Flight mode introduction .....</b>	<b>13</b>
<b>5.2 Advanced Fountion .....</b>	<b>13</b>
<b>5.3 Introduction to the Functions of Remote Controller .....</b>	<b>23</b>
<b>Appendix : .....</b>	<b>28</b>
<b>Appendix1 Product Specification : .....</b>	<b>28</b>
<b>Appendix2:LES STATUS DESCRIPTION .....</b>	<b>30</b>
<b>Appendix3 :JIYI Technical Support.....</b>	<b>31</b>

## Disclaimer

Kindly Reminder: K3-A is not a toy, please read the manual carefully before you use this product. Upon reading this, you' re deemed to agree with the disclaimer, this products is not suitable for people aged below 18 years old.

This product is a professional flight controller developed by JIYI for industrial application. Under the normal electric supply and instant condition, this controller can satisfy plant protection, mapping, Aerial photography and other purposes . JIYI is always aiming high quality, reliable and stable products. As safety consideration, we strongly recommend you to remove the propeller during the configuration, ensure the wiring connection and electric supply are in place, and stay away from crowd, fragile and dangerous objects during the flight. If any of below reason (not limited to below reason) occur during the use of our products, JIYI shall not be liable for any direct or indirect loss, damages and injuries that result from the usage of our products. JIYI shall only be responsible for flight controller damaged which is caused by the controller itself. JIYI shall not be liable for any other form of Liability and Compensation.

- 1.User do not follow the manual during the usage;
- 2.Weak structure of aircraft or damage on aircraft structure;
- 3.User using third party product which caused the abnormal flight;
- 4.User' s wrong judgment or improper handling;
- 5.User intended to against others;





6. User continue with the flight even though knew that the product is function abnormally;
7. Flying under the condition of strong interference, radio interference and prohibited area or vision unclear or blocked or unable to judge and identify the flight condition;
8. Under bad weather condition or not suitable flight condition;
9. Abnormal working condition of flight controller where caused by user tearing or modifying the JIYI product and accessories;
10. Flight where user under drunk, drug abuse or any other unhealthy condition;
11. Any others products defects which is not caused by JIYI products.

## 1. Technical Terms and Abbreviations

<b>CH</b>	<b>Channel</b>
<b>FS</b>	<b>Fail Safe Protection</b>
<b>FCU</b>	<b>Flight Controller Unit</b>
<b>PMM</b>	<b>Power Management Module</b>
<b>ESC</b>	<b>Electronic speed controller</b>
<b>JIYI</b>	<b>JIYI Robotics CO.,Ltd.</b>

## 2. Packing List

**Standard Packing:**FCU×1, PMM ×1, GPS/Magnetic Compass Module ×2, GPS Folding bracket × 2, LED Module × 1, Dupont cables× 8, Micro-USB cable×1, 3M MoveDots(ROUND)×2, 3M MoveDots (STRIPE)×2

<b>Flight Controller</b>	<b>Power Management Module</b>	<b>LED Module</b>
		
<b>GPS</b>	<b>Accessories</b>	
	<b>GPS bracket Dupont wire 3M adhesive(round&amp;stripe) USB cable(Micro-USB)</b>	

**The Optional Module :** Flow Sensor ×1; Radar Module ×1;

Bluetooth Datalink ×1 ;RTK Module×1;

### 3. Setup Wizard

#### 3.1 Aircraft Types

Supported Aircraft Types are showing in the following figures:

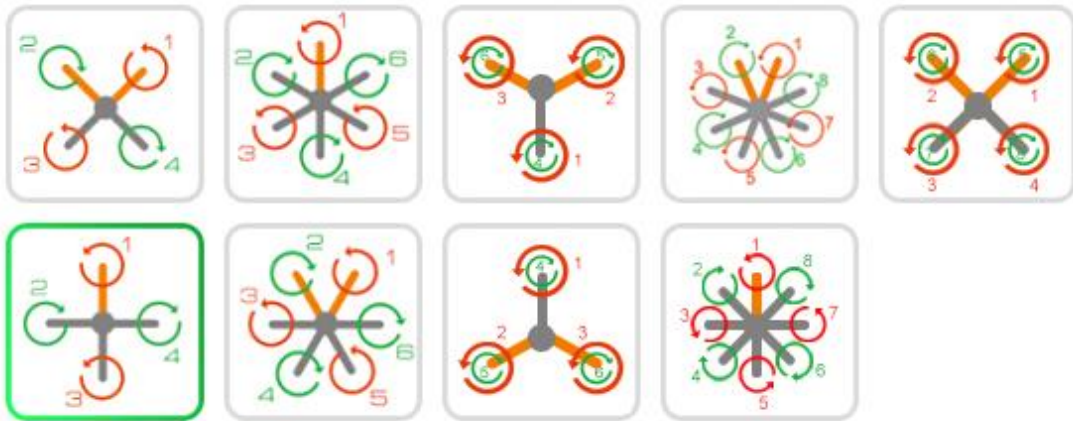

**Notes :**

- (1) It uses the yellow arms to show the nose direction;
- (2) Those marked numbers matches the input ports M1 to M8 of FCU;
- (3) The upper propellers of coaxial multicopter indicates by green and the lower indicates by red.

#### 3.2 Wiring Diagram

##### 3.2.1 Instruction of Ports

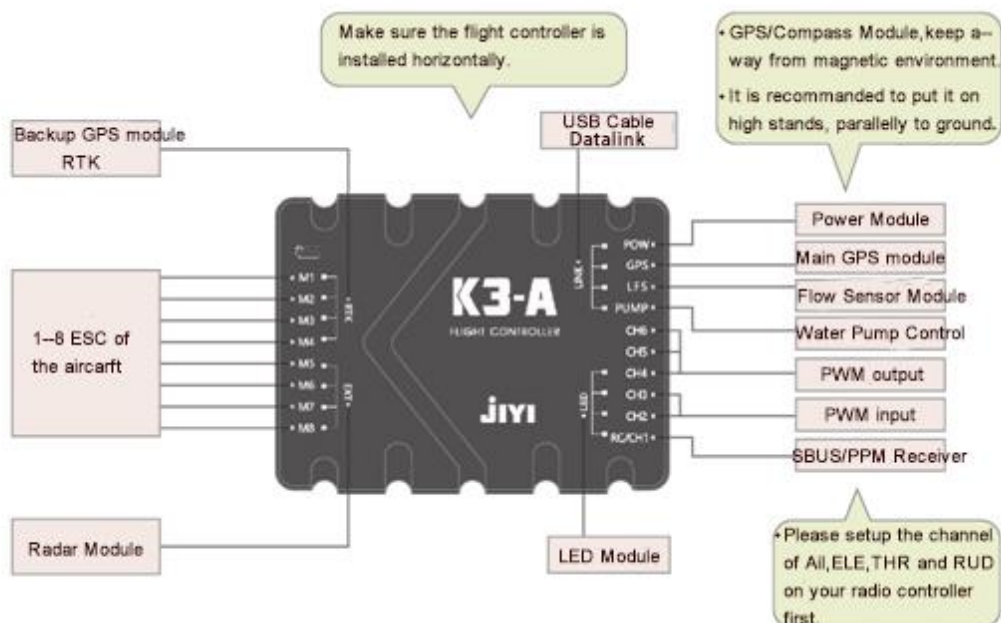

The port definitions of K3A is showing in the following table:

M1	Connects to ESC 1 #	POW	Connects to power management module
M2	Connects to ESC 2 #	GPS	Connects to GPS module
M3	Connects to ESC 3 #	LFS	Connects to flow sensor
M4	Connects to ESC 4 #	PUMP	Communicates to water pump
M5	Connects to ESC 5 #	CH6	Communicates to the second water pump
M6	Connects to ESC 6 #	CH5	PWM output, controlled by OUT2
M7	Connects to ESC 7 #	CH4	PWM output, controlled by OUT1
M8	Connects to ESC 8 #	CH3	Connects to switchlevel meter
<u>RTK</u>	Connects to GPS2 module or RTK module	CH2	Connects to percentage level meter
EXT	Connects to radar module	RC/CH1	Connects to PPM/SBUS receiver
		LINK	Use USB to connects to Assistant2 or use datalink to connect to APP
		LED	Connects to LED tricolored light module

## 2、Overall Wiring Diagram

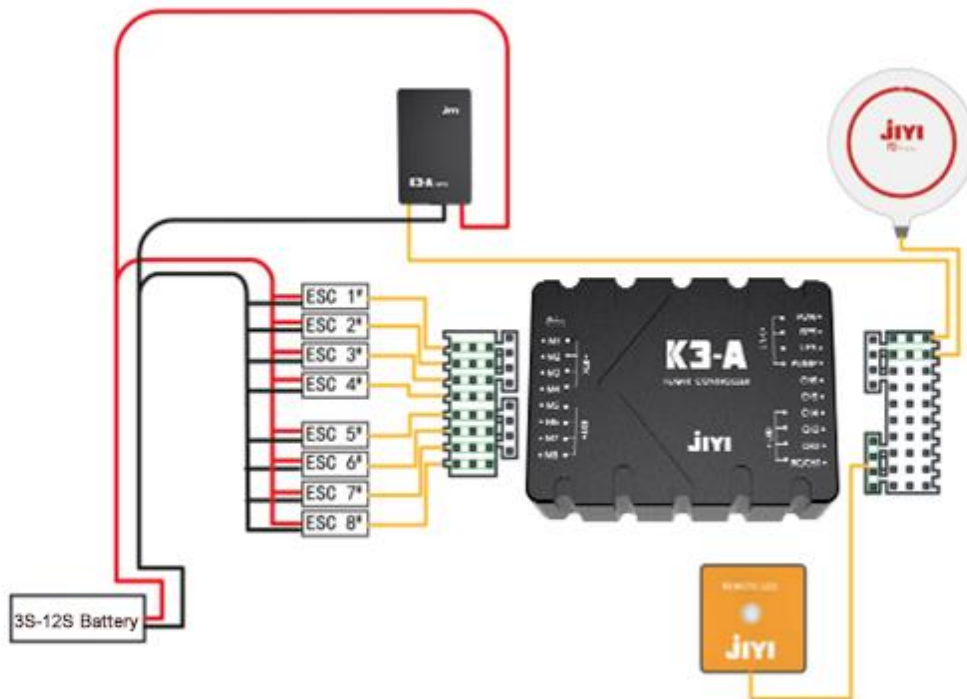

### 3.3 FCU Setup

#### 3.3.1 The Direction of K3A FCU

Please choose a direction as the following figure shown. And set the corresponding configuration in the Assistant2 Software.

PATH: Basic Setting ->Installation - > IMU Direction. ( Nose direction indicates by the red arrow).

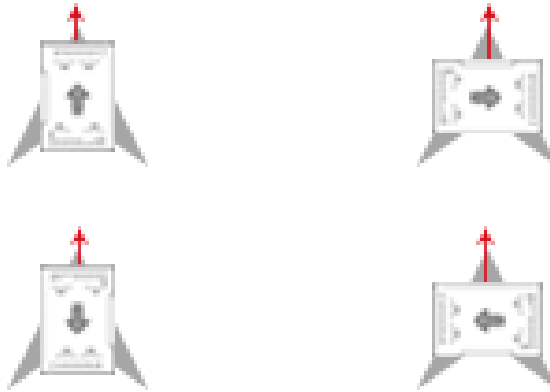

#### 3.3.2 Installation Position

- (1) The K3A FCU must be face-up. Please don't invert it and try your best to keep paralleled .
- (2) In order to guarantee the best flight effect, we suggest to install FCU horizontally in the gravity center of the aircraft.
- (3) The internal vibration reduction system has been assembled in FCU, so please use tough 3M movedots to fix the FCU.

### 3.4 GPS Setup

#### 3.4.1 Install Direction

Please choose a direction as the following figure shown.And set the corresponding configuration in the Assistant2 Software.

PATH:Basic Setting ->Installation - >GPS direction . ( Red arrow indicates the nose direction).



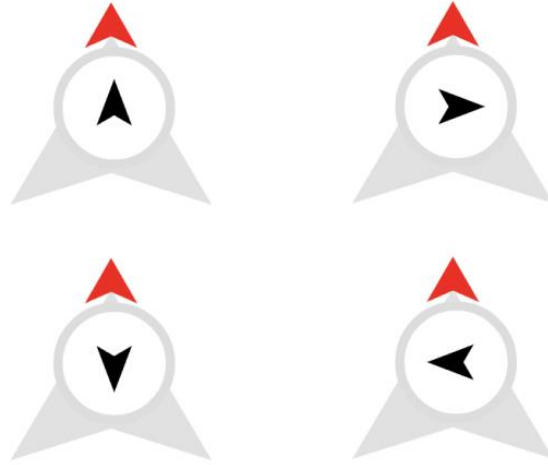

### 3.4.2 Installation Position

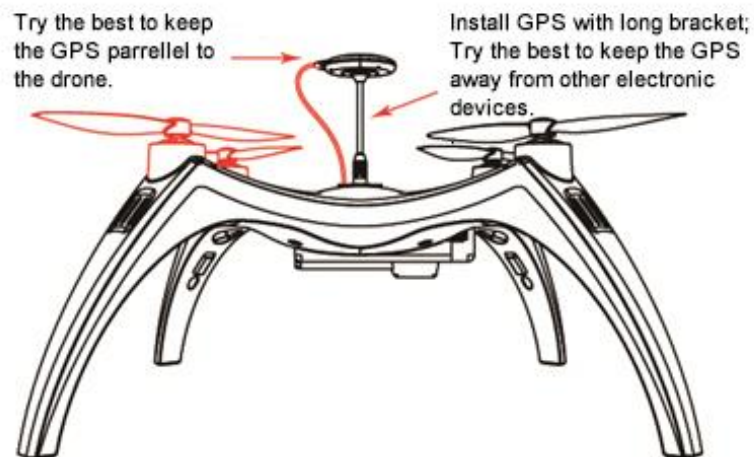

- (1) GPS module should be installed as high as possible. And keep it far away from ESC, power wires, motors and battery;
- (2) Ensure to fly in open environment (no shield);
- (3) Avoid flying under magnetic interference;
- (4) Please don't put magnetic stuff close to the GPS, otherwise it could be cause to permanent damage of the compass.

## 4. Configuring by Assistant Software

### 4.1 Installing driver and Assistant Software

- 1、 Boot up the computer, and then visit JIYI's official website ([www.jiyiuav.com](http://www.jiyiuav.com)) . Download the driver program and K3A Assistant2 software;
- 2、 Run the installation program of the driver and the assistant software installation program;
- 3、 After the installation is completed, open the assistant software. The interface is shown as below:

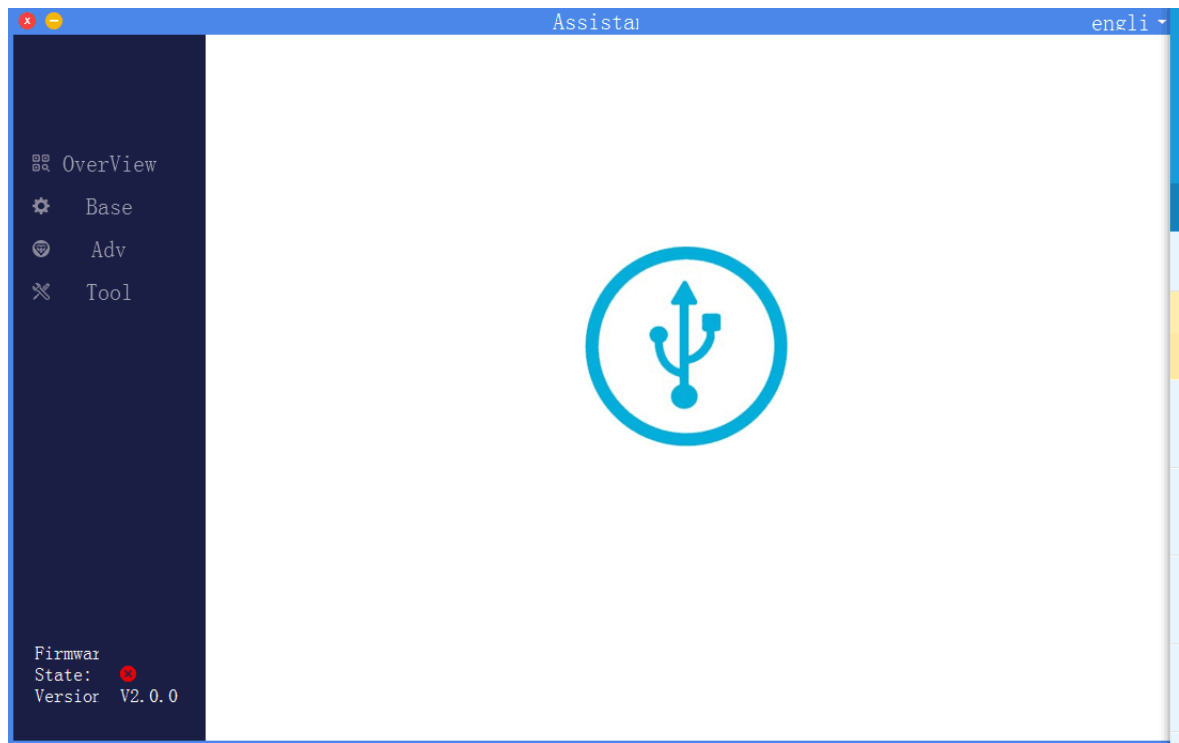

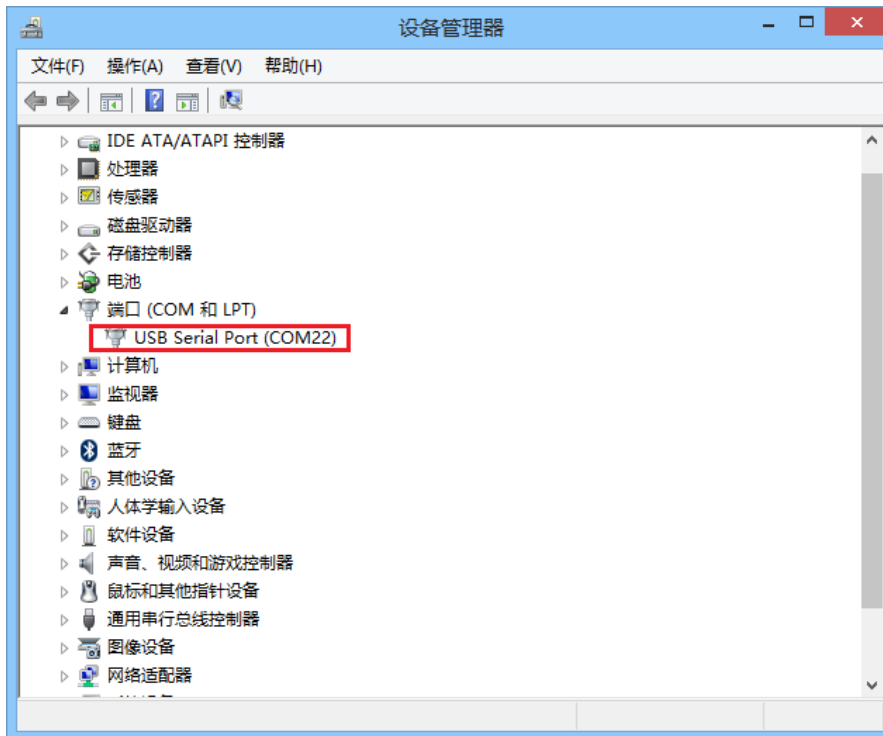

**Attention: USB port of computer just can supply 0.5A current at most for flight controller. If there are excessive peripherals mounted on flight controller, it would lead to insufficient power supply and connection failure, and at this moment it needs power supply. The propeller must be discharged when you use power supply, meanwhile the motor should be turned off.**

## 4.2 Connect to the FCU

Click the “Connect” button , the following interface shows the FCU had been connected successfully.

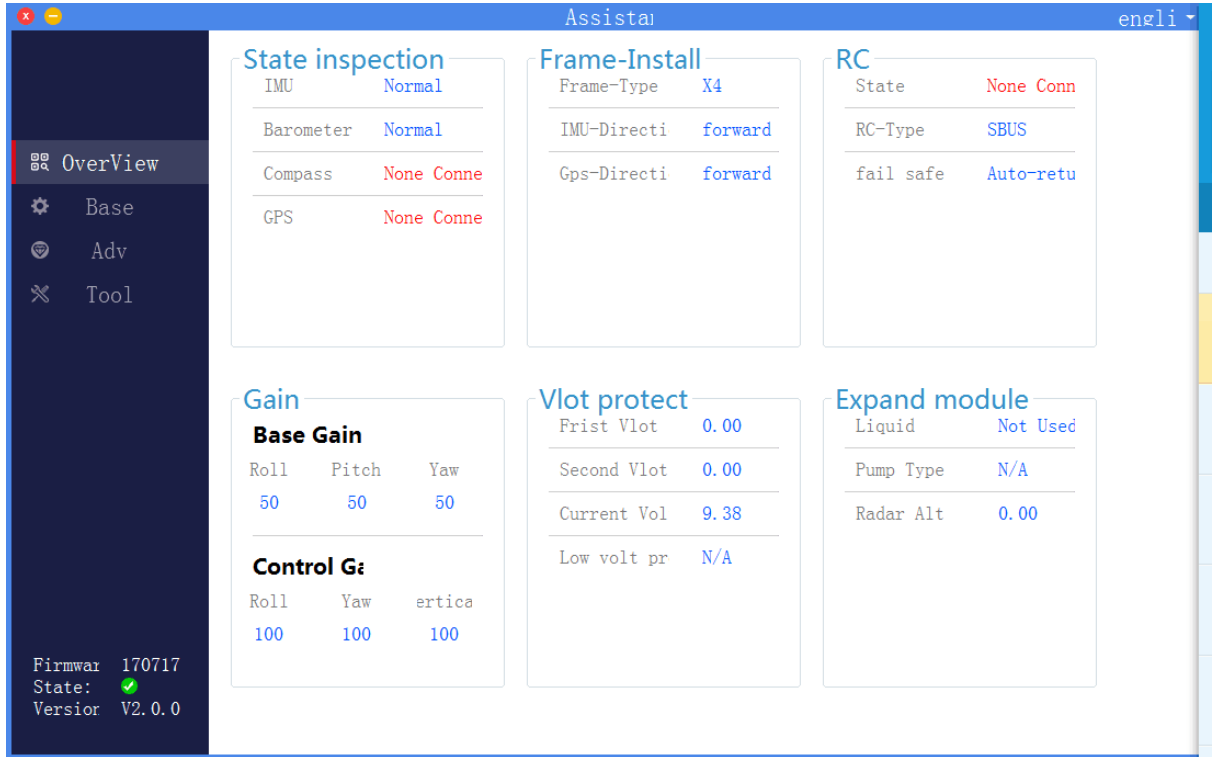

### 4.3 The configuration FCU

Please read < ASSISTANT2>

## 5. Flight

### 5.1 Flight mode introduction

#### 5.1.1 ATT-STA

ATT-STA is the basic mode of all flight mode ,which only depends on the IMU .And it couldn't be influenced by other sensors. It's the most stable and safest flight mode.

##### 1、 Working condition

The ATT-STA mode can be switched in any status. And it also supports arm and disarm the FCU. If the aircraft is in the mode, LED will be flashed single green.

##### 2、 Operation description

Switch CH5 of the remote controller to the ATT-STA mode. Arm FCU and push the throttle until the aircraft taking off. The taking-off throttle depends on the driver system of the aircraft. Because of the advanced algorithm of flight controller, you can easily make aircraft hover without controlling the throttle lever under indoors or breezeless environment.

To find the respective function of the stick, please refer to the following table:

ATT-STA		
Channel setting		Description
CH1	Control roll angle	To change the desire roll angle of aircraft
CH2	Control pitch angle	To change the desire pitch angle of aircraft
CH3	Control throttle value	Different from ATT-ALT mode, flight controller doesn't involve in altitude control. the hover-throttle value will be changed with the driver system of aircraft.
CH4	Control the rate of yaw	To change the desire rate of pitch angle

#### 5.1.2 ATT-ALT

ATT-ALT mode is suitable for central-control remote controller. In the mode, IMU and Barometer will both involve in flight control.

## 1、 Working condition

The ATT-ALT mode can be switched in any status. And it also supports arm and disarm the FCU. If the aircraft is in the mode, LED will be flashed single green.

## 2、 Operation description

Switch CH5 of the remote controller to the ATT-ALT mode. Arm FCU and push the throttle. If throttle stick under 50%, motors will be idling. And you can push the throttle stick gently to make the aircraft take off. If the throttle is placed in 50% position, the aircraft will be in alt-hold flight .

**To find the respective function of the stick, please refer to the following table:**

ATT-ALT		
Channel setting		Description
CH1	Control roll angle	To change the desire roll angle of aircraft
CH2	Control pitch angle	To change the desire pitch angle of aircraft
CH3	Control speed of altitude	Different from ATT-STA mode, flight controller would involve in altitude control. When the throttle is in the middle, the aircraft stays in constant altitude.
CH4	Control the rate of yaw	To change the desire rate of pitch angle

### 5.1.3 GPS-ANGLE

GPS-ANGLE mode is the most commonly flight mode, and it can meet with most demands of customers on flight control. In the mode, Besides IMU and Barometer, compass and GPS also involve in flight control.

#### 1、 Working condition

Owning to use GPS to control the aircraft, so it has to wait for the complete of searching satellite and achieve to the required positioning precision. You can arm the aircraft, when GPS status in normal ,good or RTK positioning. The following table shows different LED status with different GPS status.

GPS Status	Indicator Light Status	Priority
Unconnected GPS/GPS no receives satellite	Red indicator blinks for three times	Low
Bad signal	Red indicator blinks twice	low
Normal signal	Red indicator blinks once	low
Good signal	Red indicator doesn't blink	low
RTK positioning	Yellow indicator blinks once	

If the aircraft is in the mode, LED will be flashed green twice.

## 2、 Operation description

After searching satellite or RTK positioning, switch CH5 of the remote controller to the ATT-ALT mode. Arm FCU and push the throttle. If throttle stick under 50%, motors will be idling. And you can push the throttle stick gently to make the aircraft take off. If the throttle is placed in 50% position, the aircraft will be in alt-hold flight .If the aircraft is in motion, all the control sticks of remote controller return to the middle position, the aircraft will brake and hover automatically.

**To find the respective function of the stick, please refer to the following table:**

GPS-ANGLE		
Channel setting		Description
CH1	Control roll angle	To change the desire roll angle of aircraft
CH2	Control pitch angle	To change the desire pitch angle of aircraft
CH3	Control speed of altitude	When the throttle is in the middle, the aircraft stays in constant altitude.
CH4	Control the rate of yaw	To change the desire rate of pitch angle

### 5.1.4 GPS-SPEED

GPS-speed mode is the strictest flight mode to control the flight speed of aircraft, It can meet with the demands of the speed-sensitive users. In the mode, Besides IMU and Barometer, compass and GPS also involve in flight control.

#### 1、 Working condition

The working condition is as same as GPS-angle mode.

#### 2、 Operation description

The description of control stick is different from GPS-ANGLE mode, other operations are as the same as GPS-angle mode.

**To find the respective function of the stick, please refer to the following table:**

GPS-ANGLE		
Channel setting		Description
CH1	Control the rate of roll angle	Different from GPS-angle mode, the stick couldn't control the roll angle of the aircraft any more, but strictly controls the flight speed of the aircraft in roll direction.

CH2	Control the pitch of roll angle	Different from GPS-angle mode, the stick couldn't control the pitch angle of the aircraft any more, but strictly controls the flight speed of the aircraft in pitch direction.
CH3	Control speed of altitude	When the throttle is in the middle, the aircraft stays in constant altitude.
CH4	Control the rate of yaw	To change the desire rate of pitch angle

## 5.1.5 AB-MODE

### 1、Setting

Before using the mode, you need connect to the Assistant2 Software for some channel setting.

**Settings of AB record:** connect to Assistant2 Software and enter the path of “Adv”—“Plant”. Read AB operation process.

	Gear 1: close	Gear 2: record A	Gear 3: record B
AB record channel value	$p \leq 1200$	$1400 \leq p \leq 1600$	$p \geq 1800$



## 2、 Operation description

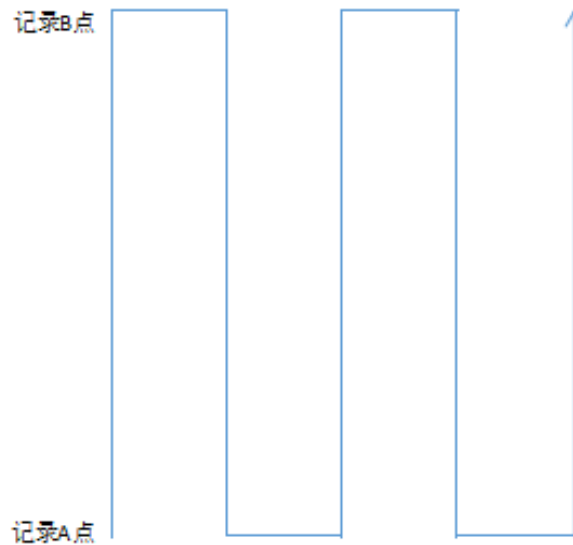

### Step 1: Record A waypoint:

Hovering in GPS mode, switch the control stick of AB record to Gear 2. If recording has finished, LED will flash yellow light for 2 seconds.

### Step 2: Record B waypoint:

Making the aircraft to fly to the wanted place and hovering the aircraft .Switch the control stick of AB record to Gear 3. If recording has finished, LED will flash green light for 2 seconds.

### Step 3: AB execution

Switch the control stick of AB mode execution.

### Step 4: Select direction

Push the CH1 to select the direction. If you push CH1 to the left, it will move to the left. If you push CH1 to the right, it will move to the right. Most important is that it has to clean AB waypoints which recorded last time before you execute those steps. Otherwise it will execute the AB points of operation settings which recorded last time.

### Step 5: Interrupt AB operation

AB operation can be interrupted by the following ways: shift CH5 bar to an other flight mode, switch control stick of AB operation to Gear 1, or switch to the return-to-home.

During the execution, LED flash green light for four times.

During the execution, the CH3 and CH4 of remote controller can be used to control the altitude and flight direction.

## 3、 Correction function

### AB points distance correction :

push pitch bar upwards or downwards, it can lengthened or shortened the AB waypoint length.

## 4、Parameters setting

Supporting the configurations of the banner and speed in AB operation by both Assistant2 Software and APP.

Assistant Software setting: connect to Assistant2 Software and enter the path of “Adv”—“Plant”. Read AB operation process.

APP setting: use data-link to connect the FCU. Please refer to the port definitions table.

## 5、Others

**Clear AB waypoints:** shift the control stick of AB records quickly for 4 to 5 times, then LED will flash red, green and yellow rapidly and alternately. This means AB points has been clearly deleted. If you forget clear AB waypoints which recorded last time, you will not be able to record new AB waypoints.

### 5.1.6 Auto-return-to-home mode

Auto-return-to-home mode provides the safety guarantee for long-distance flight and FS protection.

#### 1、Working condition

The working condition is as same as GPS-angle mode. FCU will record the current position as the return-to-home waypoint when everytime users unlock the aircraft. If the aircraft is in the mode, LED will be flashed green quickly.

#### 2、Operation description

The automatic return-to-home mode can be triggered by control stick, also can be triggered through lost control protection. When CH6 switch to one-key return-to-home position or the FCU is in FS protection status, the aircraft will automatically lift to a set altitude if the distance between the aircraft and the return waypoint is more than 2m (if the current altitude is higher than the setting return-to-home altitude, it takes the current altitude for return-to-home). During return-to-home the aircraft won't be interfered manually by the control stick channel. After the aircraft arrives at the return-to-home waypoint, firstly it will hover for about 3 seconds, and then slowly land, at this time you can control the flight status of the aircraft (but no response to throttle stick) by the ch1 ch2 ch4 channels, which making the aircraft to seek a more suitable landing place. Until the aircraft landing completes, the aircraft will lock automatically. If the distance between the aircraft and return-to-home waypoint is less than 2m, the aircraft will land and lock automatically.

## **Attentions**

1. The premise of automatic return-to-home is that the aircraft return-to-home waypoint has been recorded. If you need to use automatic return-to-home, please arm it after searching satellite . You can refer to the appendix about LED tricolored light indication and meaning.
2. When the aircraft is near people, we suggested not to switch into the automatic return-to-home mode in case of accident.

## **5.2 Advanced functions**

### **5.2.1 Cut-out and continue spraying**

If you interrupt AB operation and change battery, it will continue to execute the latest AB operation after switching the control stick to AB mode.

Please read the ASSISTANT2 description before use this functions.

### **5.2.2 One-key sidesway**

#### **1 Parameters setting**

Supporting the configurations of the banner in sidesway by both Assistant2 Software and APP.

Assistant Software setting: connect to Assistant2 Software and enter the path of “Adv”—“Plant”. Read AB operation process.

APP setting: use data-link to connect the FCU. Please refer to the port definitions table.

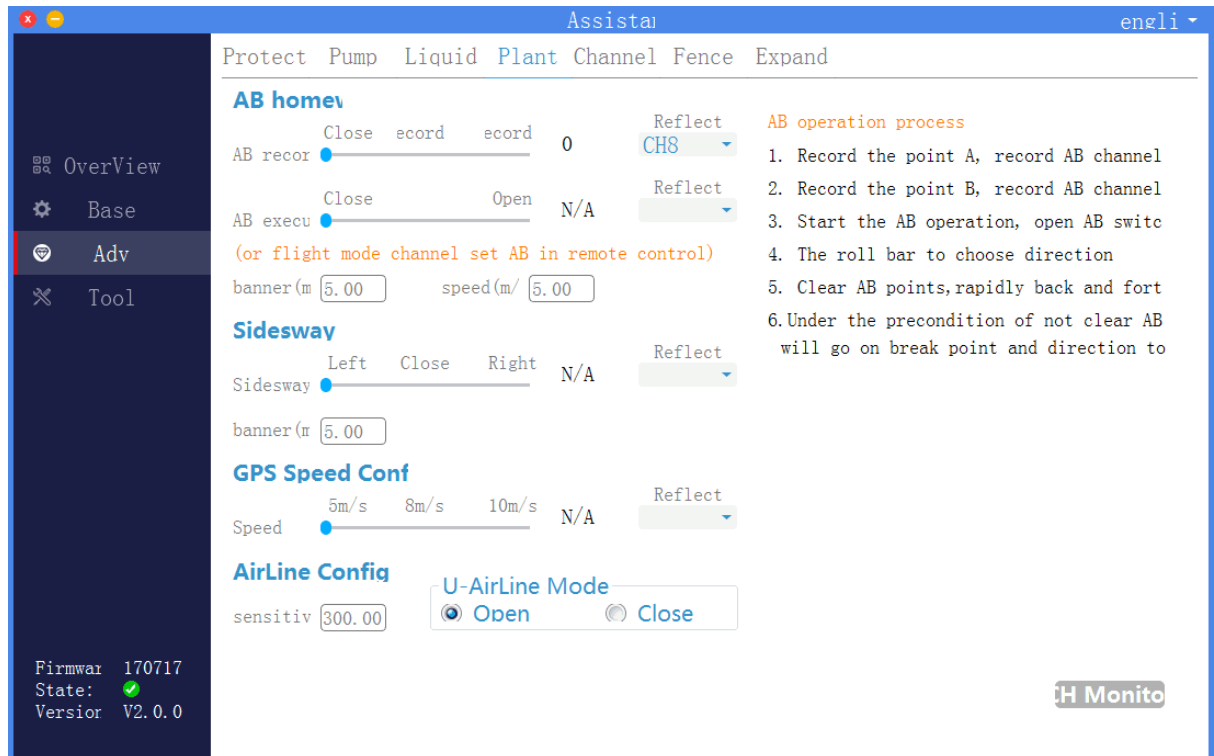

**3、Operation:** switch to “Close”—“Move to the left”—“Close”, and it will execute a left side-move once; switch to “Close”—“Move to the right”—“Close”, and it will execute a right side-move once.

### 5.2.3 Pump control function

The function is to control flow of the pump. It supports two kinds of control modes: one is manual control mode which means output of pump is controlled by the remote controller directly. the other is linkage mode which means when the pump is switched on, the flow speed of the water pump is corresponding to the horizontal flight speed of the aircraft. In other words, the higher flight speed and the larger flow.

**1、Connection :** connect the ESC signal wire of the water pump to the PUMP port on the FCU.

**2、Setting:** connect to **Assistant2 Software**, configure the channel to control the water pump.

Supporting the configurations of the PUMP by both Assistant2 Software and APP.

Assistant Software setting: connect to Assistant2 Software and enter the path of “Adv”—“Pump”.

APP setting: use data-link to connect the FCU. Please refer to the port definitions table.

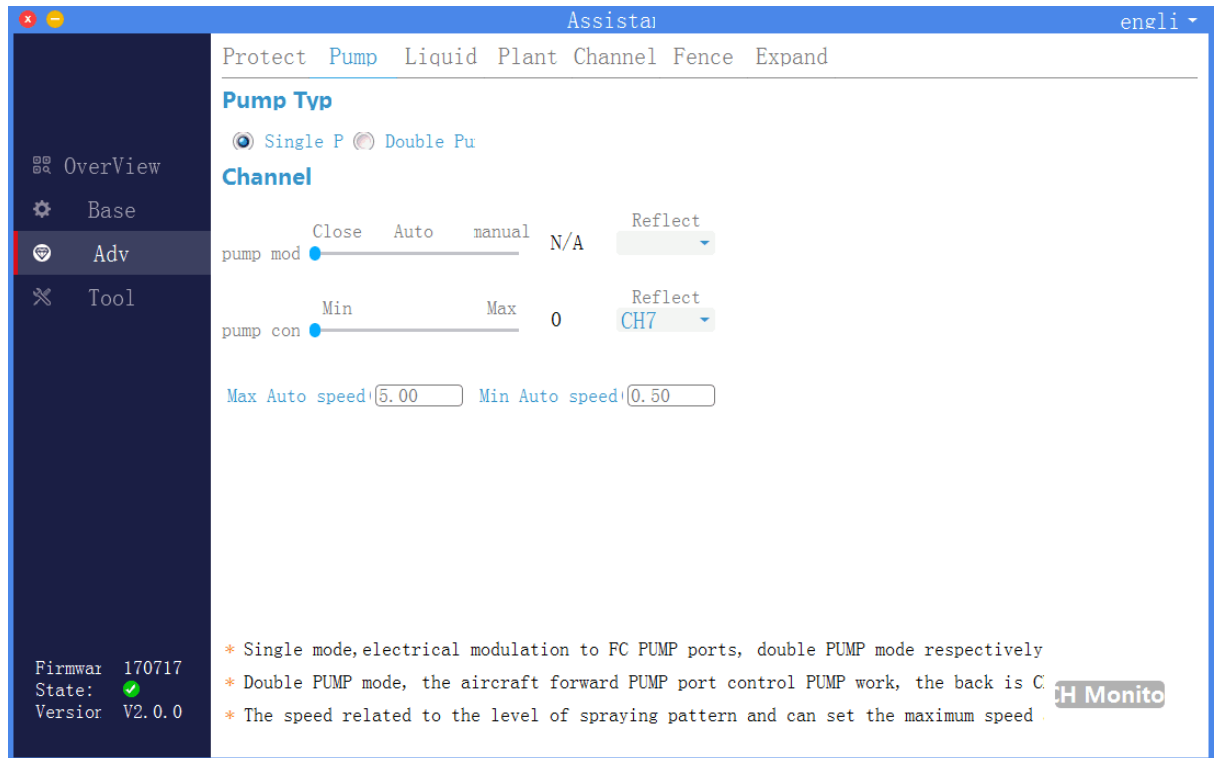

### 5.2.4 Terrain following function

Under the function, the aircraft can keep the fixed height above ground during flying.

**To use the function, you need a radar module.**

- 1、 **Connection** :connect the radar to the EXT port of the FCU;
- 2、 **Setting Up**: Setting up the radar facing downwards in the inferior part of the aircraft. Make sure no shielding barriers are in the range of 30CM diameter. Make sure it is firmly, no offset, no loosening and be dropped to ground during landing.
- 3 **Test**:when you connect the radar to flight controller, you can test in Assistant2 Software and APP whether the radar works normally or not .

Supporting the configurations of the PUMP by both Assistant2 Software and APP.

Assistant Software setting:connect to Assistant2 Software and enter the path of “Adv”—“Expand”.

APP setting: use data-link to connect the FCU. Please refer to the port definitions table.

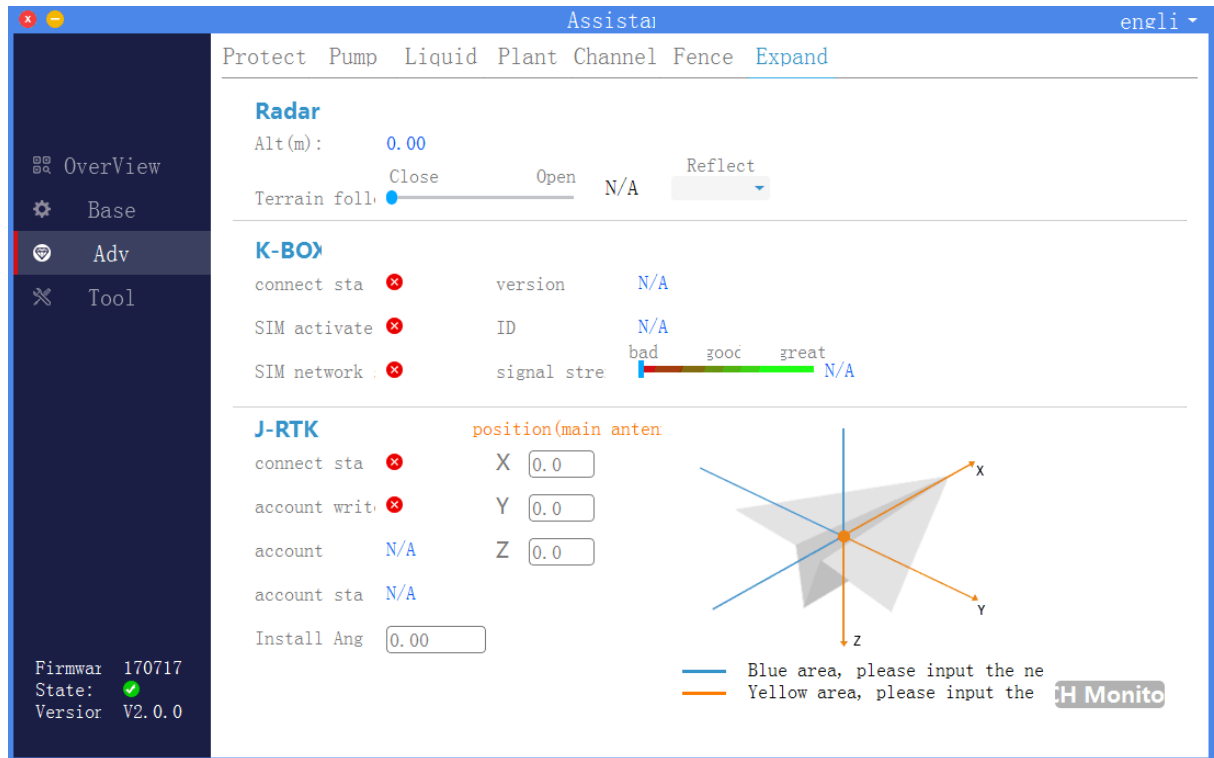

## 5.2.6 GPS Speed Shifting Function

### 1 Setting:

Supporting the configurations of the GPS Speed Shifting by both Assistant2 Software and APP.

Assistant Software setting: connect to Assistant2 Software and enter the path of “Adv”—“plant”.

APP setting: use data-link to connect the FCU. Please refer to the port definitions table.



**2、 Operation:**the maximum flight speed can be limited at 5m/s,8m/s or 10m/s by switching the control stick when the aircraft is flying under GPS speed mode.

### 5.3 Introduction to the Functions of Remote Controller

#### 5.3.1 Arm And Disarm

##### 1.Arm

You can arm the aircraft as is shown in following figure. The motor will be in an idling status after being armed.

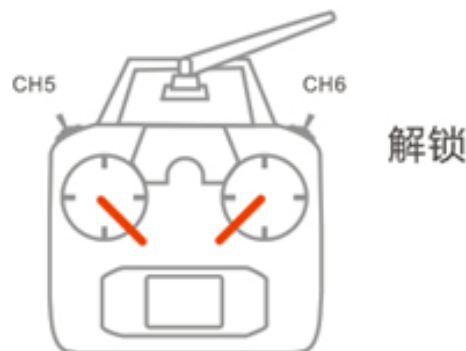

## 2. Disarm

### (1) Immediate disarmed

under all control modes, as long as motor is turned on, motors will stop spinning immediately after you pull the sticks as it is shown in following figure.

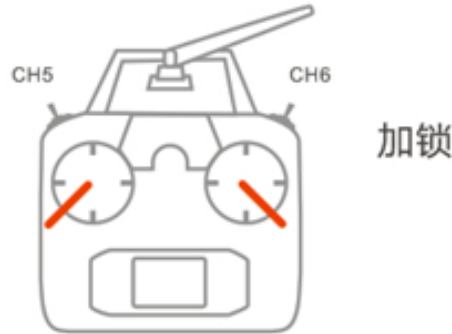

**Note:** Do not pull the stick as is shown in the above figure during flight, otherwise the motor will stop spinning immediately.

### (2) Auto disarmed

a. No matter what flight mode it is in, if the aircraft doesn't take off and at the same time the throttle is put at lowest level after it is armed, and there are no operations in 3 seconds, the motors will be disarmed automatically.

b. Except in ATT-STA mode, FCU can auto recognize landing, and the aircraft will stop automatically.

c. Except in ATT-STA mode, if the throttle is put at lowest level, the motor will not stop spinning.

## 5.3.2 Accelerometer calibration

Flight controller supports horizontal accelerometer calibration with remote controller, and the calibration method is as follows.

- 1、 Place aircraft horizontally.
- 2、 Switch the return-to-home channel to the highest position, push the control stick of the remote controller as ↘ ↗ (American style remote controller) or ↗ ↘ (Japanese style remote controller), and when there is an alternating blinking of red, green and yellow light, accelerometer calibration starts. The calibration will complete in 1 or 2 second(s), and then the LED light will blink normally.

## 5.3.3 Compass Calibration

Flight controller supports compass calibration on remote controller.



Quickly shift back and forward the 5<sup>th</sup> channel before the flight controller is armed, and then it will enter compass calibration mode. The solid yellow light indicates it is in horizontal calibration. Place aircraft horizontally at the moment, and do clockwise rotation around the axis along with the gravity direction. When the LED green light is solid on, it enters in vertical direction calibration. Put the nose face-down, rotate the aircraft round the axis along with the gravity direction until the LED red light, green light and yellow light blink alternately, and that indicates calibration is completed.

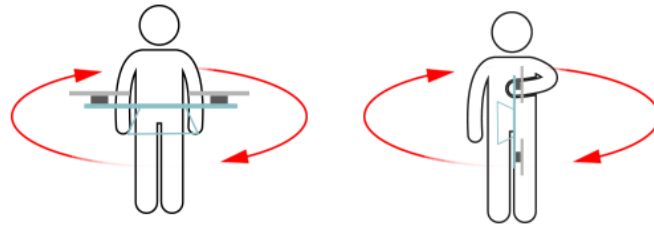

After calibration is completed, it will exit from calibration mode automatically, LED indicator blinks normally.

**Attentions:**

- When the flight field changes, you need to calibrate magnetic compass.
- Before calibration, please check whether there's strong magnetic interference nearby or not.

### 5.3.4 Motor Test

Motor test function includes motor sequence test and movement direction test. It is mainly used to inspect whether the installation sequence number and rotation direction of motor are correctly or not. It can avoid the error installation and prevent accident from happening.

#### 1、Motor Sequence Test

When the aircraft is disarmed, push the LH stick of the remote controller as ↙ and make the RH stick to do anti-clockwise circling (American style remote controller), and then the motor sequence testing is triggering. Motors will start idling spinning in sequence from No.1 motor to No.8 motor.

Japanese style remote controllers: 1. push the LH stick on the remote controller as ↙ and push the RH stick as ↘, keep them in the position. 2. And then push sequentially the LH stick as ↖, the RH stick as ↙, the LH stick as ↗, the RH stick as ↘. The left rod shall be maintained at the most left side and the right rod shall be maintained at the most downward side during you push the sticks. Repeat the 4 stick pushing actions in the 2<sup>nd</sup> step in sequence, the motor sequence test will be triggered.

**Attention:** Under normal conditions, motor sequence test can be triggered after one time stick pushing action. But if the sticks are pushed in wrong positions, the motor sequence test can only be triggered after repeating the 4 stick pushing actions in step

2<sup>th</sup>.

## 2、 Move Direction Test

After the aircraft is armed, the propeller of the aircraft will spin lowly and steadily in idle speed (power output will be shut down if there is no action in 3s). You can judge whether the propeller rotates are in reverse direction or not by the remote controller. For example, when you are pushing the front control stick under the idle speed, the rear propeller of aircraft should start rotating while the front propeller of aircraft should stop rotating. Likewise, when you are pushing the left control stick under the idle speed, the left propeller of aircraft should stop rotating while the right propeller of aircraft should start rotating.

### 5.3.5 Fail-safe Protection

Firstly you are required to set the FS protection of remote controller correctly according to the user's manual of remote controller.

Setting in the assistant2 software (path : Base -RC) .When GPS satellite signal is good, no matter what kind of aircraft is in, FCU will execute automatic return-to-home if the signal of receiver is lost. If the signal of remote controller is recovered during return-to-home, switch the flight mode control channel back and forward to get control right if you want to control aircraft again.



## **6 User Manual of Mobile Ground Station**

Please refer to user manual of mobile ground station for detailed information.

## Appendix :

### Appendix1 Product Specification :

#### Global Feature

##### Function Description

Supporting PPM and S-BUS receivers

Supporting double GPS

Supporting RTK module

Supporting ground station

Supporting OSD module

Supporting low voltage protection

Supporting FS protection

#### Peripheral Equipment

**supported Aircraft Module:** Axis distance within 1500mm, quadcopter (I4 ,X4),

hexacopter (I6 , X6 , Y6 , IY6, IY6 coaxial),

octocopter (X8 , I8 , V8)

**Supported ESC:** PWM ESC of 490Hz and below

**Recommended RC:** SBUS receiver

**PC system requirement:** Windows XP SP3, Windows 7, Window 8, IOS X

#### Basic Specs

**Working Voltage:**

**Core flight controller:** 4.8v to 5.3v

**Power module:** input 11.1v to 50v (recommended 3S to 12S LiPo), maximum

output 3A@5V

**LED Light Module:** 5V

**Battery voltage:** 3S to 12S

**Power:** less than 2Watt

**Working environment temperature:** -10°C—60°C

**Storage environment temperature:** -40°C—60°C

**Weights:**

**Core Flight Controller:**56g

**GPS/magnetic compass module:** 45g

**LED light module:** 13g

**Power Module:** 39g

**Size:**

**The Core Flight Controller:**53.5mm×40.0mm×21.0mm

**GPS/Compass module:**63.0mm(diameter)×15.0mm

**LED light module:**24mm×24mm×8mm

**Power Management Module:**53.5mm×34.5mm×14.5mm

## **Flight Performance**

**Hovering Accuracy:** Horizontal:±1.5m

Vertical:±0.5m

**Maximum Tilt Angle:**30°

**Max Yaw Angular Velocity:**150°/s

**Max Vertical Volocity:**6m/s

**Maximum Wind Resistance:** Sustained wind: Force 4

Gusty wind: Force 5

**Flight Modes and Functions:** ATT-STA Mode, ATT-ALT Mode, GPS-SPEED Mode, GPS-ANGLE Mode, AB Mode, Auto Return to Home Mode, Failsafe Protection, Low Battery Warning Protection, Cut-out and continue spraying, One-key Sidesway, Water Pump Control, Terrain Follow, GPS Velocity Switching, Supporting Datalink and Ground Station, supporting configuration on mobile phone

## Appendix2:LES STATUS DESCRIPTION

Indication of Flying Mode	Status Indicator	Priority Level
Attitude(ATT-STA, ATT-ALT)	green indicator blinks once	Low
GPS mode(angle, speed)	green indicator blinks twice	Low
Function mode(circling, patrol and agriculture etc)	green indicator blinks three times	Low
Start of intelligence direction	green indicator blinks four times	Low
Self-driving mode(ground station control, return-to-home )	green indicator blinks quickly	Medium
Indication of GPS	Status Indicator	Priority Level
Disconnection of GPS or GPS didn't receive the satellite	red indicator blinks three times	Low
Poor GPS signal	red indicator blinks twice	Low
Ordinary GPS signal	red indicator blinks once	Low
Strong GPS signal	No blink of red indicator	Low
RTK positioning	yellow indicator blinks once	
Indication of Low Voltage Alarm	Status Indicator	Priority Level
Level one alarm	yellow indicator blinks three times	Low
Level two alarm	yellow indicator blinks quickly	High

<b>Indication of double-faced calibration</b>	<b>Status Indicator</b>	<b>Priority Level</b>
Horizontal calibration	Yellow indicator is solid on	Medium
Vertical calibration	Green indicator is solid on	Medium
Calibration failure	Red indicator is solid on	Medium
Calibration success	Alternating blink among red, green and yellow indicators	
<b>Indication of spherical calibration</b>	<b>Status Indicator</b>	<b>Priority Level</b>
Being calibrated	Alternating blink among red, green and yellow indicators	Medium
Calibration success	The indicator returns to normal	Medium
<b>Indication of accelerometer Calibration</b>	<b>Status Indicator</b>	<b>Priority Level</b>
Being calibrated	Alternating blink among red, green and yellow indicators	Medium
Calibration success	The green indicator is solid on	Medium
<b>Indication of Abnormal status</b>	<b>Status Indicator</b>	<b>Priority Level</b>
Lost control of remote controller	Quick blink of red indicator	High
Compass is disturbed/ abnormal	Alternating blink between green and yellow indicators	High
GPS loses the signal	Alternating blink between green and red indicators	High
IMU vibration is too fierce/ abnormal	Alternating blink between red and yellow indicators	High
<b>Indication of Other Status</b>	<b>Status Indicator</b>	<b>Priority Level</b>
Initialization of power up	Alternating blink among red, green and yellow indicators	High
Unlock	Alternating blink among red, green and yellow indicators	High
Unlock failure	Red indicator is normally on	High

## Appendix3 :JIYI Technical Support

If you have any problem during your usage, please contact JIYI for technical support.

You can download relevant information from JIYI official website.

**JIYI official website:**[www.jiyiuav.com](http://www.jiyiuav.com)

**Technical support:**[support@jiyuav.com](mailto:support@jiyuav.com)